

User Instructions

IMPORTANT: Read these instructions fully before using the sitelight. Retain these instructions for future reference.

The Faithfull Bluetooth LED Cordless Sitelight

This cordless rechargeable 30W LED sitelight provides a convenient portable 'lead free' light source.

With the option to listen to your favourite music or radio station using its integral Bluetooth speaker system, utilising your mobile phone, MP3 player or tablet.

The sitelight also features a USB outlet 'Power Bank' function permitting you to recharge personal items such as mobile phones, MP3 players or tablets using a compatible USB lead.

Specifications

Product Code: FPP SLLED30TB
Battery pack: 7.4V 8800mAh
Li-ion removable battery

Bulb type: 30W LED
LED lifetime: 30,000 hours
Brightness: 2400 Lumens
Beam angle: 110 degrees
Colour temperature: 6500K
IP rating: IP54

240V AC/DC Wall charger:

Model: LGSPS120150BS
Input: 100-240VAC 50-60Hz
0.8A
Output: 12V DC 1500mA

12V DC charger

Sitelight Operation

The sitelight may be used in conjunction with the supplied tripod or as a portable lamp.

Setting Up the Tripod

1) Loosen the centre leg retaining brace (1) thumbscrew and push down to spread the tripod legs to their required position, tighten the thumbscrew to lock the legs into place.

2) To adjust the pole height. Loosen the appropriate collar lock (2) while supporting the post with your other hand, then raise or lower the post to the desired height and tighten the collar lock.

3) Attach the lamp head to the tripod cross bar using the two supplied thumbscrews.

Stand Alone Operation

4) Remove the lamp head from the tripod, the back bracket may then be positioned to function as a support stand.

To adjust its position loosen both side thumbscrews (3) and push the bracket down to support the lamp in the required angle and re-tighten the thumbscrews.

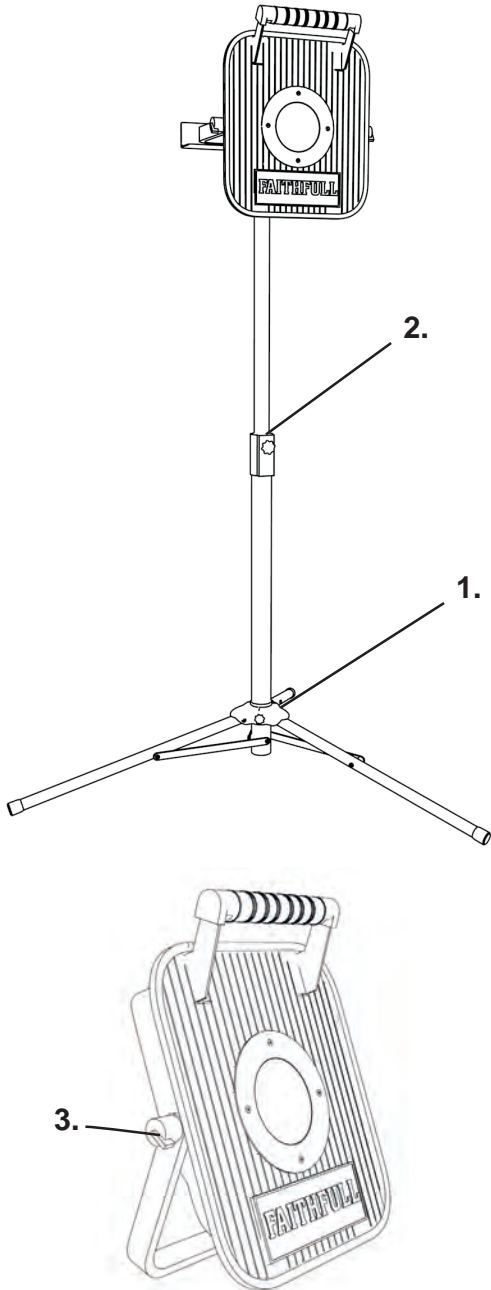

Charging the LED Sitelight

The LED sitelight should be fully charged before being used for the first time. This will ensure that the battery gives its best performance now and on future re-charging cycles.

The AC and DC charging adapters are for recharging the battery supplied with this product only.

The battery pack with this product may be charged while the lamp is in use or removed to be recharged. This feature allows the user to cycle batteries to provide a constant supply of light when charging facilities are not readily available.

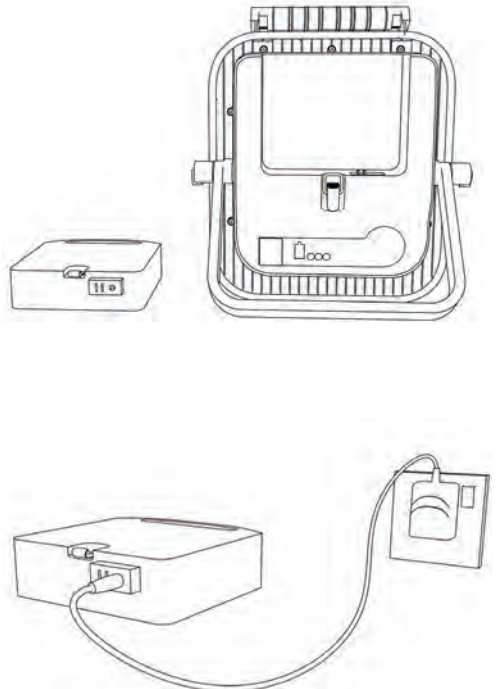

Charging Options

Charging the LED sitelight

Fig 1.

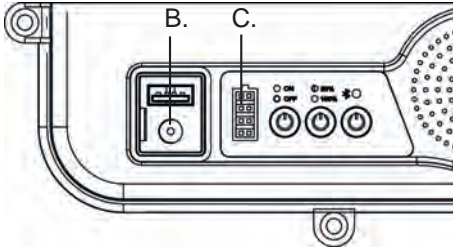

B: DC input hole (Charging the battery)

C: Battery indicator

Fig 2.

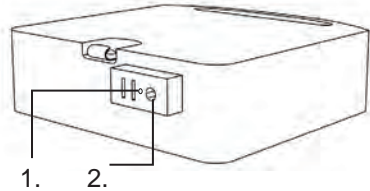

1: Indicator lamp

2: Charging socket

240V AC Charging

Charging the battery while fitted in the lamp.

1) Plug the charging cables jack plug into the recharging socket of the sitelight Fig 1. (B) located under the black rubber cover.

2) Plug the adapter into a 240V socket and switch the socket on (if applicable).

3) The charging indicator lamp Fig 1. (C) can display up to four green bars, which indicates the state of charge of the battery. When charging the battery the indicator will flash and the bars will progress up until all four bars are green, indicating that the battery is fully charged.

4) The battery will be fully charged after approximately 6 hours or when four green bars are illuminated in the charging indicator. Disconnect the jack plug from the sitelight, remove the adapter from the wall socket or switch off.

NB the recharging time will vary when the lamp is also in use during charging.

Cycling Batteries

Removing batteries for charging

1) Unclip and remove the battery from the lamp.

2) Plug the charging cables jack plug into the recharging socket on the top of the battery Fig 2. (2).

3) Plug the adapter into a 240V socket and switch the socket on (if applicable).

4) The charging indicator lamp on the battery Fig 2. (1) will glow Red indicating that the battery is on charge and go out when the battery is fully charged.

5) The battery will be fully charged after approximately 6 hours. Disconnect the jack plug from the battery, remove the adapter from the wall socket or switch off.

Safety Precautions

Use 240V AC charging adapter indoors in a dry location only. Do not use the charger in the vicinity of flammable liquids or materials.

Always plug the adapter directly into a 240V outlet in a suitable location.

Store in dry location and do not allow the charging adapter to come in contact with water.

12V DC Charging

With the battery fitted in the lamp

1) Plug the charging cables jack plug into the recharging socket of the sidelight Fig 1. (B) located under the black rubber cover.

2) Plug the adapter into the vehicles 12V DC cigarette lighter or accessory power socket.

3) The charging indicator lamp Fig 1. (C) can display up to four green bars, which indicates the state of charge of the battery. When charging the battery the indicator will flash and the bars will progress up until all four bars are green, indicating that the battery is fully charged.

4) The battery will be fully charged after approximately 6 hours or when four green bars are illuminated in the charging indicator. Disconnect the jack plug from the sidelight, remove the DC adapter from the outlet socket.

NB: *Under no circumstance should the lamp be operated when a vehicle is in motion as the driver's sight could be seriously impaired.*

Cycling Batteries

Removing batteries for charging

6) Unclip and remove the battery from the lamp.

7) Plug the charging cables jack plug into the recharging socket on the top of the battery Fig 2. (2).

8) Plug the adaptor in to the vehicles 12V DC cigarette lighter or accessory power socket.

9) The charging indicator lamp Fig 2. (1) on the battery will glow red indicating that the battery is on charge and go out when the battery is fully charged.

10) The battery will be fully charged after approximately 6 hours. Disconnect the jack plug from the battery, remove the adapter from the wall socket or switch off.

To prevent overheating do not charge for more than 9 hours.

Safety Precautions

The DC charging adapter can be used in most vehicles by plugging into the 12V DC cigarette lighter or accessory power socket. Consult your vehicle owner's manual for further information on operating 12V DC accessories.

Do not drive the vehicle while charging, as an unsecured light or battery may be a hazard during certain driving manoeuvres. Store in dry location and do not allow the charging adapter to come in contact with water.

Do not store charging adapter where temperatures may exceed 122°F (50°C). Use only the DC charging adapter supplied with the light.

Do not attempt to charge the light with an adapter that is not compatible as this could result in a fire, damage to the torch or personal injury.

Use only the AC or DC charging adapters supplied with the light. Do not attempt to charge the light with an adapter that is not compatible as this could result in a fire, damage to the light or personal injury.

Lamp Controls:

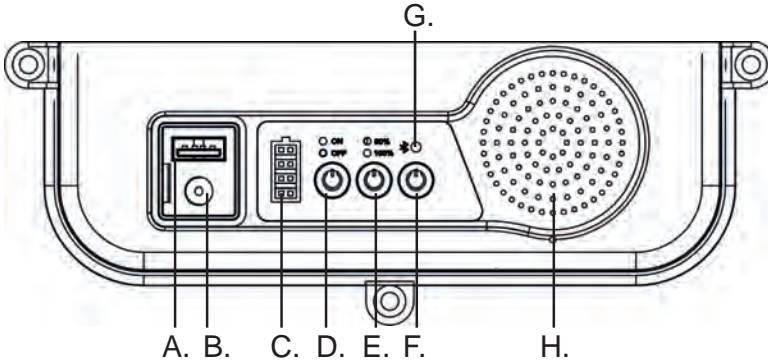

- A: USB output socket (Charging devices)
- B: DC input socket (Charging the battery)
- C: Battery indicator
- D: ON/OFF Switch

- E: 50%,100% brightness switch
- F: Bluetooth pairing switch
- G: Bluetooth indicator light
- H: Speaker

Switching on the Lamp

Depress the on /off switch (D) to activate the lamp. The output may be adjusted to either 100 or 50% by depressing the output switch (E).

The battery charge indicator will flash when battery is becoming low on power.

USB Power Bank

The battery in this product also functions as a 'Power Bank' using a USB output socket. Most small electronic devices such as mobile phones, MP3 players or tablets are now supplied with USB charging leads which can be connected to the lamps USB output and used to recharge the device. Always use the USB lead supplied by the manufacturer of your device to ensure compatibility with your product.

NB Some manufacturers do incorporate authentication chips in their products to prevent the use of third party chargers, we therefore cannot guarantee that this function will work with all devices.

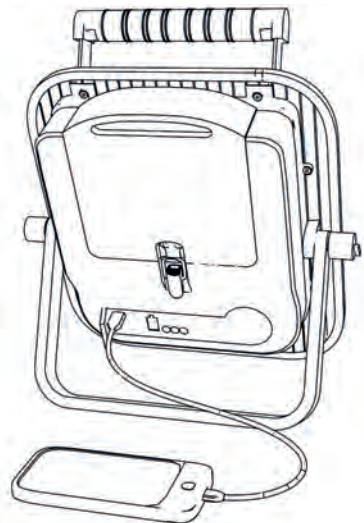

Bluetooth Pairing

Pairing your device

How to connect and pair your device with the Bluetooth speaker.

- 1) **Depress the Bluetooth pairing switch (F) the Blue indicator light (G) will illuminate to confirm that the device is active and ready for use.**
- 2) **Set your Bluetooth device to 'Discover' the lamp speaker.**
- 3) **From the Bluetooth device list select the device name 'LED Lamp' and press to pair.**
- 4) **The lamp speaker will then confirm speaking 'Bluetooth connected successfully'.**
- 5) **The Bluetooth speaker is now ready for use.**
- 6) **The Bluetooth connection can be terminated by depressing the pairing switch (F) a second time.**

NB *Pairing occurs when two Bluetooth devices communicate with each other and establish a connection. A record of information is then stored in the memory of each device. Once you have paired with the lamps speaker, you should not need to pair to it again.*

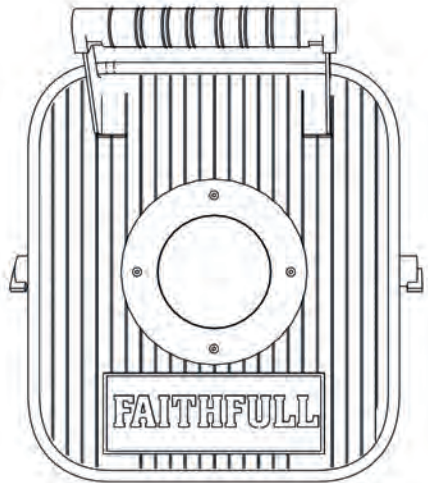

Safety Precautions

Always use 240V AC charging adapter indoors in a dry location only. Exposure to damp or wet conditions could cause electrocution or damage to adapter.

Always plug the adapter directly into a 240V outlet in a suitable location.

Do not use the charger in the vicinity of flammable liquids or materials.

Do not use the charging adapter in combination with any extension cord, electrical generators, or step-up transformers.

Do not operate the unit until it is completely free of moisture. If the adaptor becomes submerged in water, discontinue use immediately and contact your local Faithfull retailer for a replacement charger unit.

Do not store charging adapter where temperatures may exceed 122°F (50°C).

Store in a dry location and do not allow the charging adapter to come in contact with water, rain or snow. If the charging adapter comes into contact with water, place in a dry location at room temperature, on a soft absorbent towel and allow to dry thoroughly.

Use only the AC charging adapter supplied with the light. Do not attempt to charge the light with an adapter that is not compatible as this could result in a fire, damage to the light or personal injury.

The battery charge indicator will flash when battery is becoming low on charge. To prevent overheating do not charge for more than 9 hours.

FAITHFULL TOOLS

Phoenix House,

3 White Lodge Business Estate, Hall Road,
Norwich, Norfolk, NR4 6DG, United Kingdom

E-mail: enquiries@faithfulltools.com

 www.fairthfulltools.com